

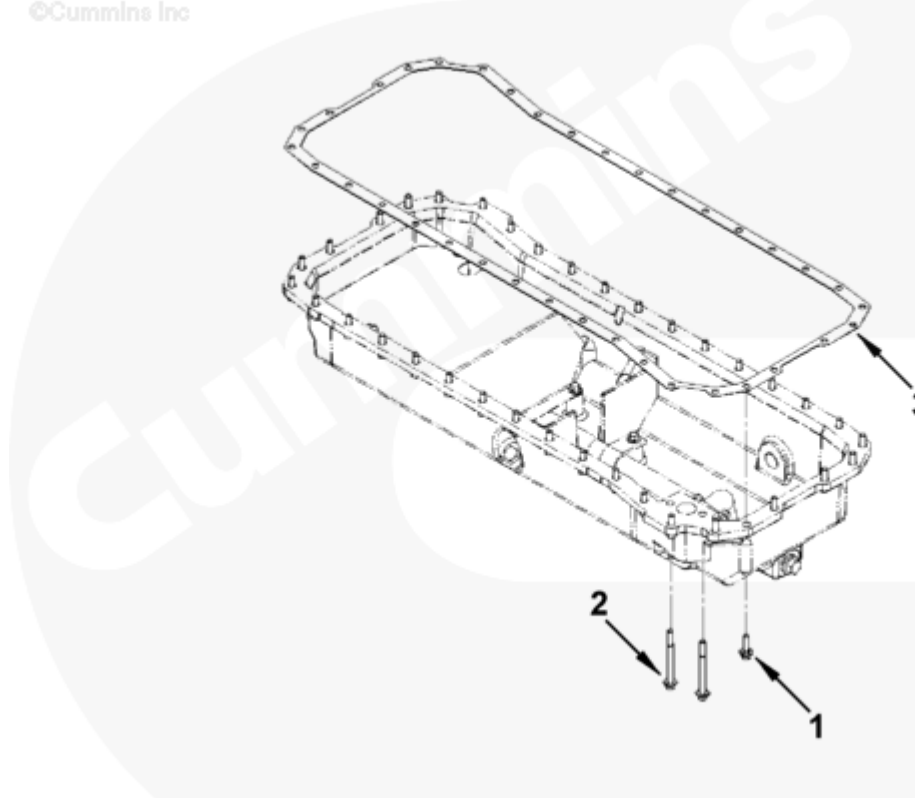

Parts Catalog - Option Detail

Electronic Parts Catalog - Option Detail				
Option	Group	Graphic	Film Card	Date
OP9712-05	07.01	op955gd	T	24-OCT-00
Engines	4B3.9, 6A3.4, 6B5.9, B GAS INTERNATIONAL CM556, B4.5, B4.5 CM2350 B129B, B4.5 CM2350 B146C, B4.5 CM2350 B147B, B4.5 RGT, B4.5S, B5.9 G, B5.9 GAS PLUS CM556, B5.9 LPG, B5.9 LPG PLUS CM556, B6.7 CM2350 B121B, B6.7 CM2350 B135B, B6.7 CM2350 B136C, B6.7 CM2350 B148B, B6.7 G CMOH6.0 B125, B6.7N CM2380 B150B, B6.7S, F3.8 CM2350 F120B, F3.8 CM2350 F128C, F3.8 CM2350 F132B, F3.8 F102, G3.9, G5.9, G5.9 CM558, ISB (CHRYSLER), ISB CM2150, ISB CM2150 E, ISB CM550, ISB CM850, ISB/ISD4.5 CM2150 B119, ISB/ISD4.5 CM2150 SN, ISB/ISD6.7 CM2150 B120, ISB/ISD6.7 CM2150 SN, ISB/ISD6.7 CM2880 B126, ISB3.9 CM2220 B107, ISB4.5 CM2150, ISB5.9G CM2180, ISB6.7 2010 DCX PICKUP, ISB6.7 2013 DCX CHASSIS CAB, ISB6.7 CM2150 SQ, ISB6.7 CM2250, ISB6.7 CM2350 B101, ISB6.7 CM2350 B103, ISB6.7 CM2350 B142, ISB6.7 CM2670 B153B, ISB6.7 G CM2180 B118, ISBE CM2150, ISBE CM800, ISBE2/ISBE3 CM850, ISBE4 CM850, ISD4.5 CM2150, ISD6.7 CM2880 D101, ISF2.8 CM2220, ISF2.8 CM2220 AN, ISF2.8 CM2220 EC, ISF2.8 CM2220 ECF2, ISF2.8 CM2220 F101, ISF2.8 CM2220 F117, ISF2.8 CM2220 F122, ISF2.8 CM2220 F126, ISF2.8 CM2220 F129, ISF2.8 CM2220 IAN, ISF3.8 CM2220, ISF3.8 CM2220 AN, ISF3.8 CM2220 F103, ISF3.8 CM2220 F110, ISF3.8 CM2220 F116, ISF3.8 CM2220 F134B, ISF3.8 CM2220 IAN, ISF3.8 CM2350 F109, ISF4.5 CM2220 F123, ISG11 CM2880 G106, ISG11 CM2880 G108, ISG12 CM2880 G107, ISG12 CM2880 G109, ISG12 G CMOH6.0 G111, QSB3.9 30 CM550, QSB3.9 CM2880 B138, QSB4.5 30 CM550, QSB4.5 CM2150 B108, QSB4.5 CM2250 B131, QSB4.5 CM2250 EC, QSB4.5 CM2350 B106, QSB4.5 CM2350 B122			

©Cummins Inc



op955gd

[SMALL](#) | [MEDIUM](#) | [LARGE](#)

Cart	Ref No	Part Number	Part Description	Required	Remarks
View My Cart					
		OP9712-05	Oil Pan Mounting		Oil Pan Mounting...(More)

					Engine Family: B Series
					Cylinders: 6
					Bedplate Capability: Without
					Required Oil Pan Material:
					Cast Aluminum
					Oil Pan Type: Non-Isolated
					For Internally Cast Oil
					Suction Tube: Yes
<input type="checkbox"/>	1	3900631	Hexagon Flange Head Cap Screw	36	M8 X 1.25 X 25.
<input type="checkbox"/>	2	3902112	Hexagon Flange Head Cap Screw	2	M8 x 1.25 x 80
	3	3938161	Oil Pan Gasket	1	

© 2019 Cummins Inc., Box 3005, Columbus, IN 47202-3005 U.S.A.
Terms of Use and Disclaimers | Recommended System Requirements
Need Assistance? Please click on the Contact Us button in the top right corner of any page.